

Cavity protection against rust

Pos. Treatment area

Evt. Remarks

1 Front boot lid

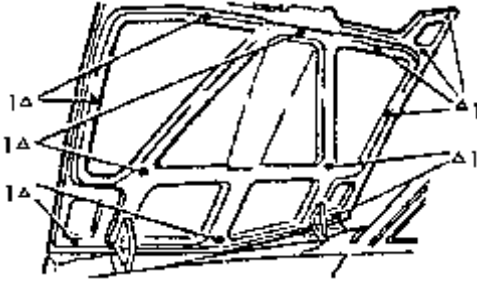

2 Bottom in boot

Temporary remove plugs

3 Longitudinal members, front top

4 Longitudinal members, front lower

Temporary remove plugs

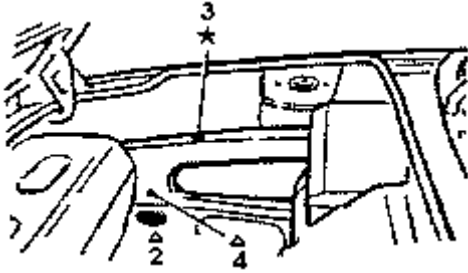

5 Front wings, front part

Temporary remove plugs, open headlamp pods

16 Front wings, rear part

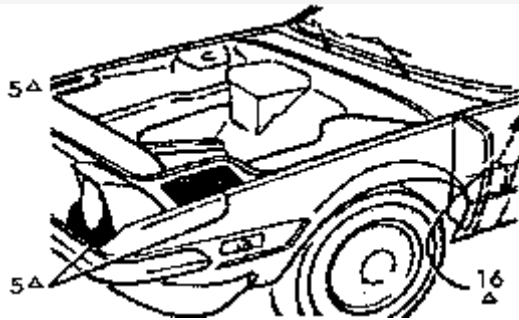

6 A-stolpe

Temporary remove plugs

7 Rear wings, front part

Temporary remove plugs

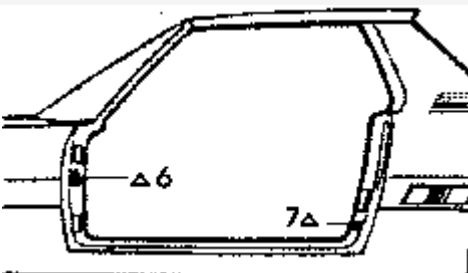

8 Doors

Temporary remove plugs

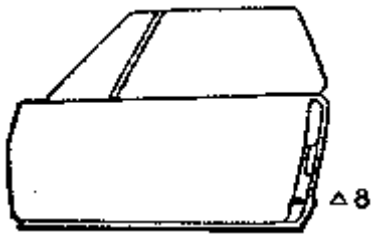

9 Crossmember in top of engine compartment

Temporary remove plugs

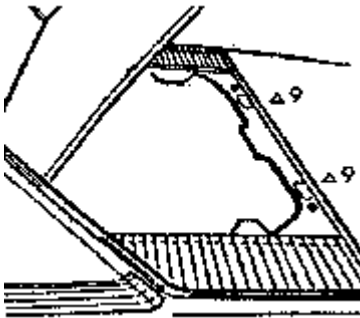

10 Rear wings, rear part

11 Longitudinal members, rear

Temporary remove plugs

12 Rear panel

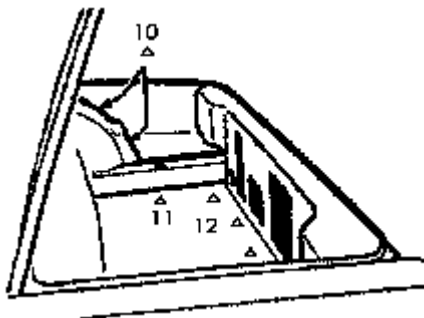

13 Front wings, front part

14 Crossmember in cabin floor front

Temporary remove plugs

15 Door sill middle section

Temporary remove plugs, Drill hole if necessary

16 Front wings, rear part

17 Door sill outer section

Temporary remove plugs

18 Crossmember in floor

Temporary remove plugs

19 Jack consoles

20 Center tunnel behind fueltank

Temporary remove plugs

21 Crossmember middle

Temporary remove plugs

22 Rear crossmember

Temporary remove plugs

23 Reinforcements

Temporary remove plugs

